



CALIBRE – KALIBER – CALIBRE 1155 A

 $13\frac{1}{4}''''$

ø 30,00 mm

Hauteur mouvement

Werkhöhe

Movement height

7,90 mm

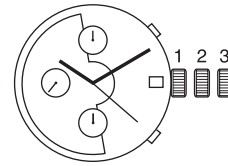

Réserve de marche / Gangreserve / Power reserve

44 h

Nombre de rubis / Anzahl Rubine / Number of jewels

25

Fréquence / Frequenz / Frequency

4 Hz (28'800 A/h)

Angle de levée / Hebungswinkel der Unruh / Angle of lift

50°

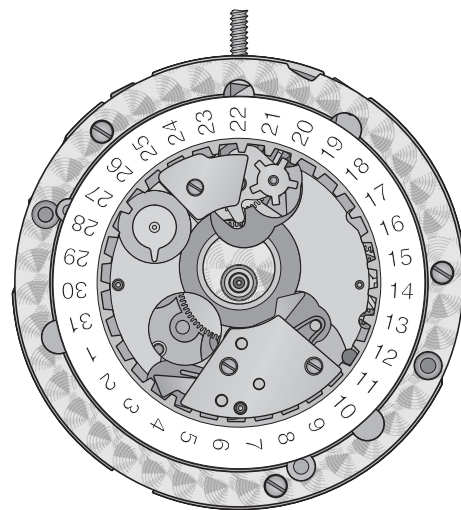

Français
Deutsch
English

Informations générales – Allgemeine Informationen – General information

Correction de la date

La correction de la date est déconseillée entre 22 h et 02 h.

Pose des aiguilles

Les aiguilles doivent impérativement être posées sur le posage correspondant.

Outillage

Porte-mouvement (bague) 502 110 0221
Poosage aiguilles 502 110 0231

Estrapade No. 8 502 150 0008
Clé de réglage Etachron 502 200 0061
Clé d'extraction du piton 502 200 0062

Lubrifiants

Moebius 9010 (2 ml) 504 200 0001
Moebius SYNT-HP-500 504 5012
Moebius SYNT-HP-1300 504 5013
Moebius 9504 504 5014
Moebius 9415 504 100 0003
Kluber P 125 504 100 0071

Datumkorrektur

Die Datumskorrektur zwischen 22 Uhr und 02 Uhr ist nicht empfohlen.

Zeigersetzen

Die Zeiger müssen unbedingt auf dem entsprechenden Werkhalter gesetzt werden.

Werkzeug

Werkhaltering 502 110 0221
Werkhalter zum 502 110 0231

Zeigersetzen
Federwinder No. 8 502 150 0008
Etachron Regulierschlüssel 502 200 0061
Schlüssel zum 502 200 0062
Spiralklötzchen entfernen

Schmiermittel

Moebius 9010 (2 ml) 504 200 0001
Moebius SYNT-HP-500 504 5012
Moebius SYNT-HP-1300 504 5013
Moebius 9504 504 5014
Moebius 9415 504 100 0003
Kluber P 125 504 100 0071

Date correction

Date correction between 22h00 and 02h00 is not recommended.

Hands fitting

It is mandatory to set the hands on the corresponding movement holder.

Tools

Movement holder (ring) 502 110 0221
Movement holder for 502 110 0231

hands fitting
Mainspring winder No. 8 502 150 0008
Etachron adjustment key 502 200 0061
Stud extraction key 502 200 0062



Lubricants

Moebius 9010 (2 ml) 504 200 0001
Moebius SYNT-HP-500 504 5012
Moebius SYNT-HP-1300 504 5013
Moebius 9504 504 5014
Moebius 9415 504 100 0003
Kluber P 125 504 100 0071

Phase 1

Liste des fournitures par ordre d'assemblage
 Bestandteilliste in Montagerihenfolge
 Parts listed in order of assembly

- | | |
|-----------|----------------|
| 1 = 410 | 7 = 3454 (1x) |
| 2 = 407 | 8 = 437 |
| 3 = 401 | 9 = 450 |
| 4 = 443/1 | 10 = 453 |
| 5 = 435 | 11 = 445 |
| 6 = 440 | 12 = 2551 (2x) |

- | | | |
|---|---|--------------------------|
|  | Graisse
Fett
Grease | Moebius 9504 |
|  | Huile épaisse
Dickflüssiges Öl
Thick oil | Moebius HP-1300SC |
|  | Très faible lubrification
Sehr kleine Menge
Very little lubrication | Moebius HP-1300SC |

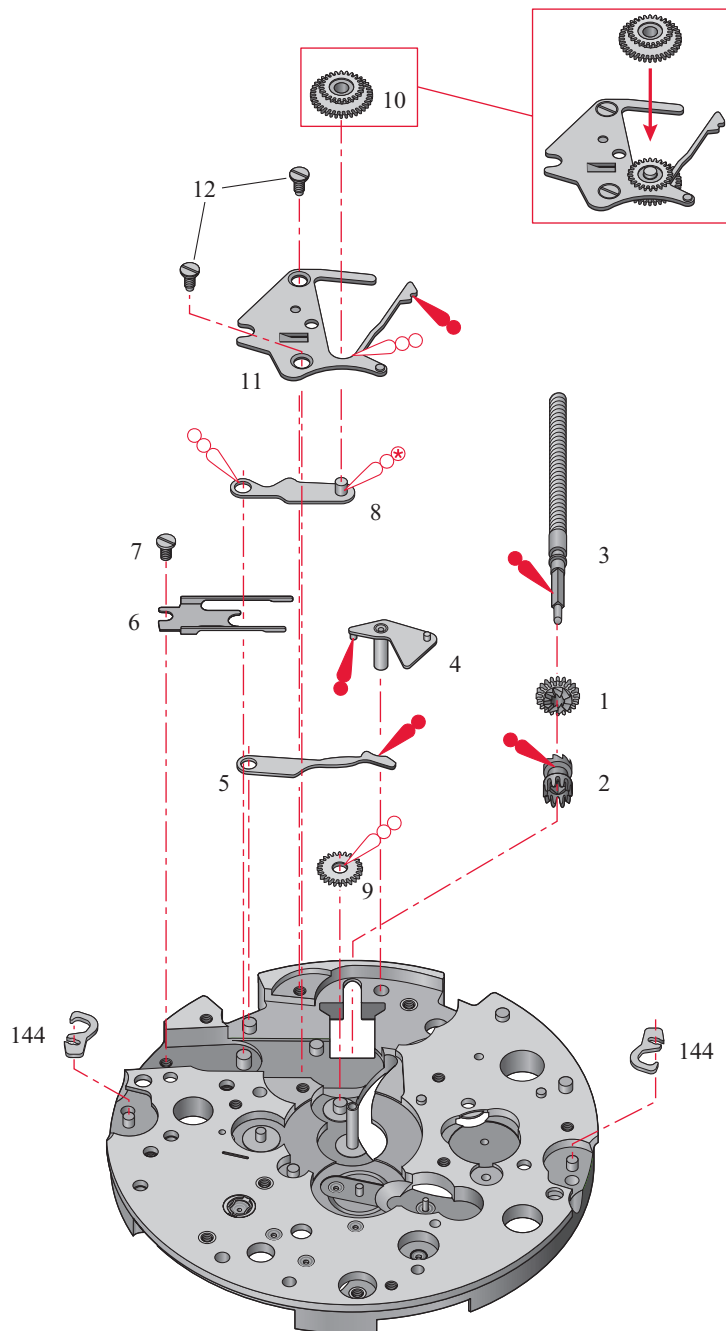

Phase 2

Liste des fournitures par ordre d'assemblage
 Bestandteilliste in Montager Reihenfolge
 Parts listed in order of assembly

1 = 182	11 = 423
2 = 705	12 = 3454 (2x)
3 = 224	13 = 415
4 = 210	14 = 3454 (1x)
5 = 201/1	15 = 710
6 = 9433	16 = 125
7 = 106	17 = 3453 (2x)
8 = 3453 (3x)	18 = 121/4
9 = 8062	18 = 721
10 = 420	19 = 3457 (1x)

Huile fine

Dünnflüssiges Öl

Fine oil

Moebius 9010

Graisse spéciale pour levées

Spezial Fett für Hebungsteine

Special grease for pallet stones

Moebius 9415

Graisse

Fett

Grease

Kluber P125

Huile épaisse

Dickflüssiges Öl

Thick oil

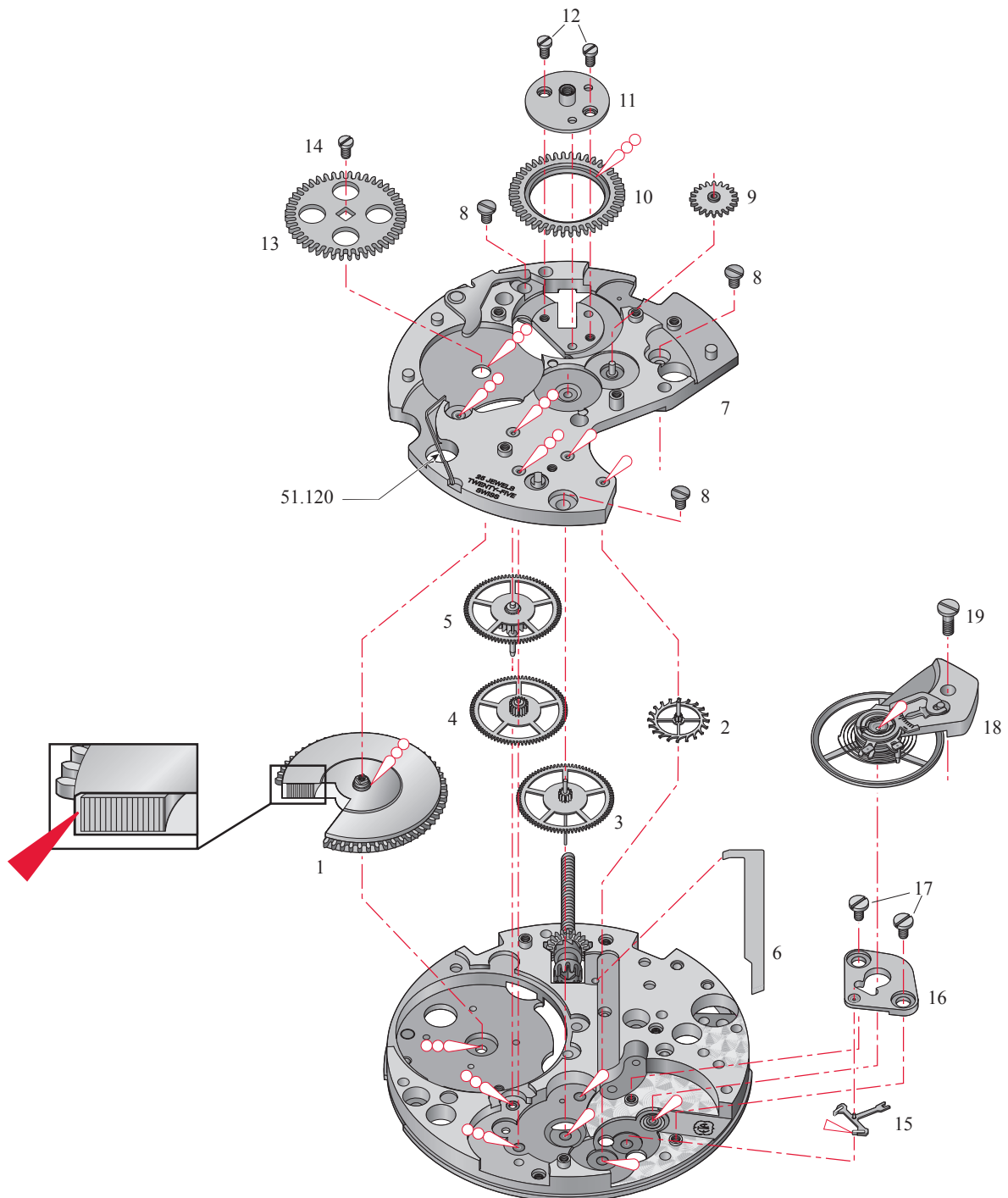

Moebius HP-1300SC



Phase 3

Liste des fournitures par ordre d'assemblage
 Bestandteilliste in Montagerihenfolge
 Parts listed in order of assembly

- | | |
|---------------|----------------|
| 1 = 8556 | 8 = 3453 (1x) |
| 2 = 8171 | 9 = 8500 |
| 3 = 3455 (1x) | 10 = 3453 (2x) |
| 4 = 8660 | 11 = 8335 |
| 5 = 1482 | 12 = 8140 |
| 6 = 8290 | 13 = 3455 (1x) |
| 7 = 8200 | |

- | | |
|---|------------------|
|  | Graisse |
| | Fett |
| | Grease |
|  | Huile épaisse |
| | Dickflüssiges Öl |
| | Thick oil |

Moebius 9504



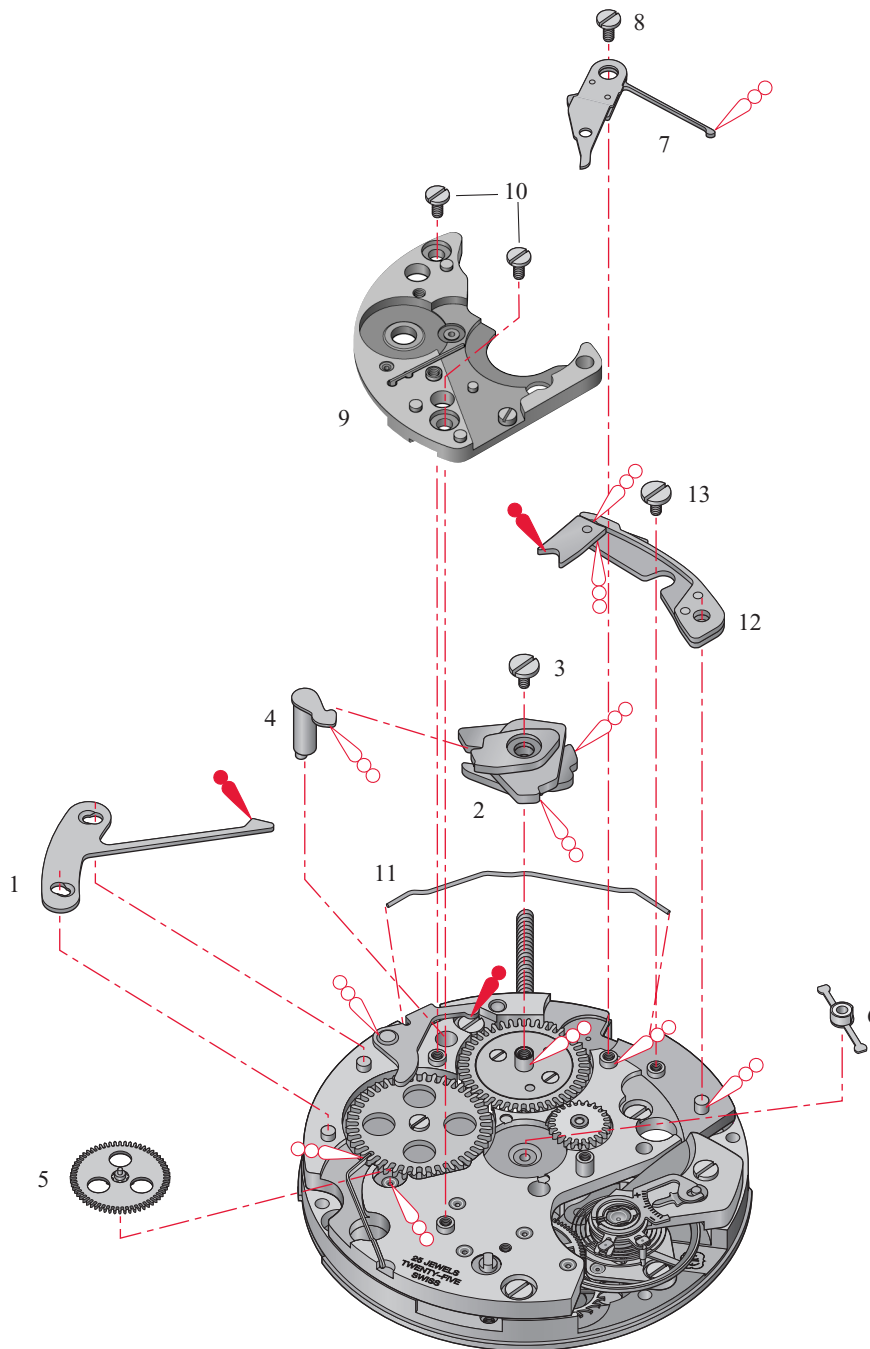

Moebius HP-1300SC



Phase 4

Liste des fournitures par ordre d'assemblage
 Bestandteilliste in Montager Reihenfolge
 Parts listed in order of assembly

- | | |
|----------|----------------|
| 1 = 8000 | 9 = 3453 (3x) |
| 2 = 8020 | 10 = 8350 |
| 3 = 8086 | 11 = 8270 |
| 4 = 8079 | 12 = 3453 (1x) |
| 5 = 1481 | 13 = 8320 |
| 6 = 8220 | 14 = 1143/1 |
| 7 = 1488 | 15 = 2841 (1x) |
| 8 = 1142 | |

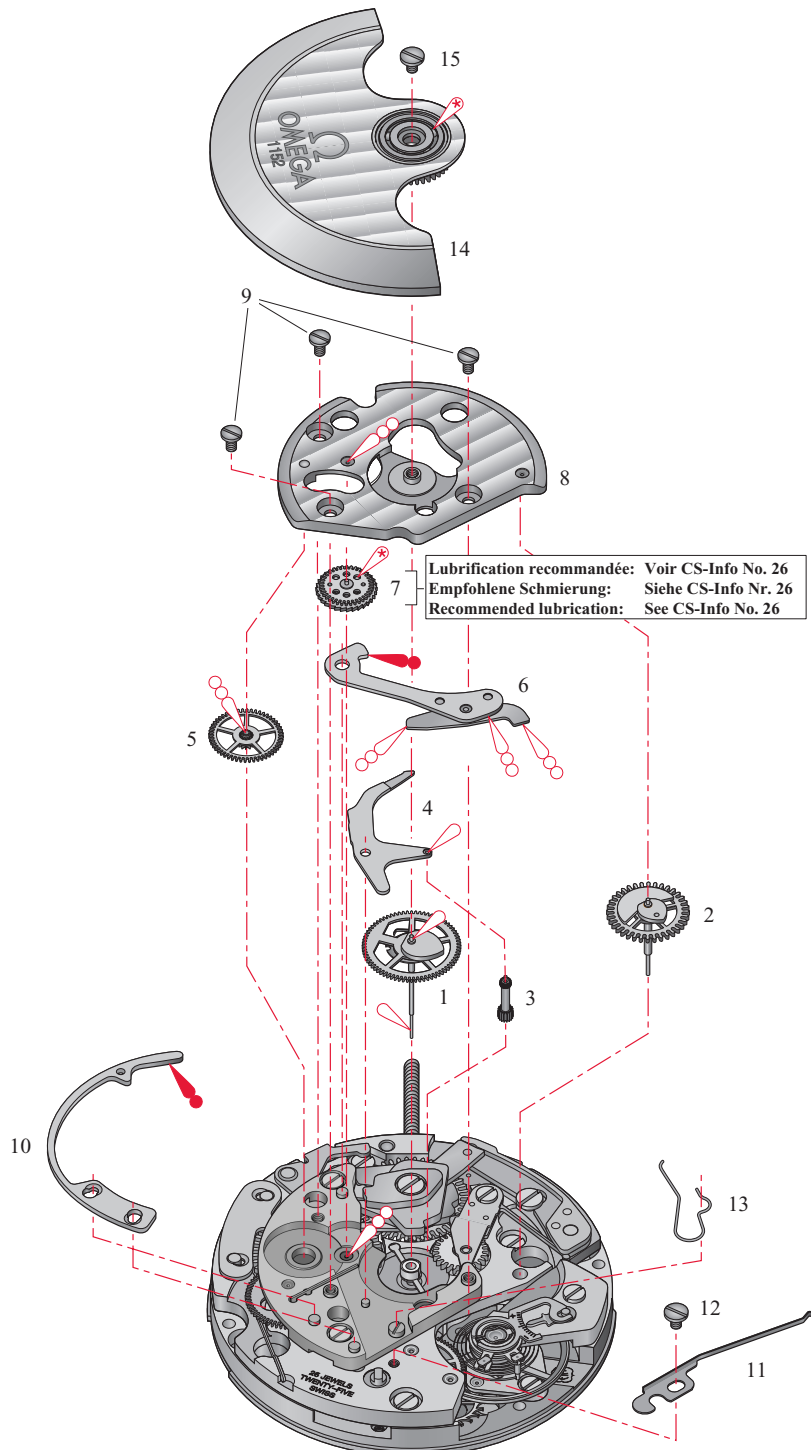

- | | | |
|---|---|--------------------------|
|  | Huile fine
Dünflüssiges Öl
Fine oil | Moebius 9010 |
|  | Très faible lubrification
Sehr kleine Menge
Very little lubrication | Moebius 9010 |
|  | Graisse
Fett
Grease | Moebius 9504 |
|  | Huile épaisse
Dickflüssiges Öl
Thick oil | Moebius HP-1300SC |



Phase 5

Liste des fournitures par ordre d'assemblage
 Bestandteilliste in Montager Reihenfolge
 Parts listed in order of assembly

- | | |
|----------|------------------|
| 1 = 240 | 8 = 8600 |
| 2 = 243 | 9 = 2543 |
| 3 = 260 | 10 = 255 |
| 4 = 8670 | 11 = 2556 |
| 5 = 8680 | 12 = 2551 |
| 6 = 8730 | 13 = 3454.1 (3x) |
| 7 = 8690 | |

- | | | |
|---|---|--------------------------|
|  | Graisse
Fett
Grease | Moebius 9504 |
|  | Très faible lubrification
Sehr kleine Menge
Very little lubrication | Moebius 9504 |
|  | Huile épaisse
Dickflüssiges Öl
Thick oil | Moebius HP-1300SC |

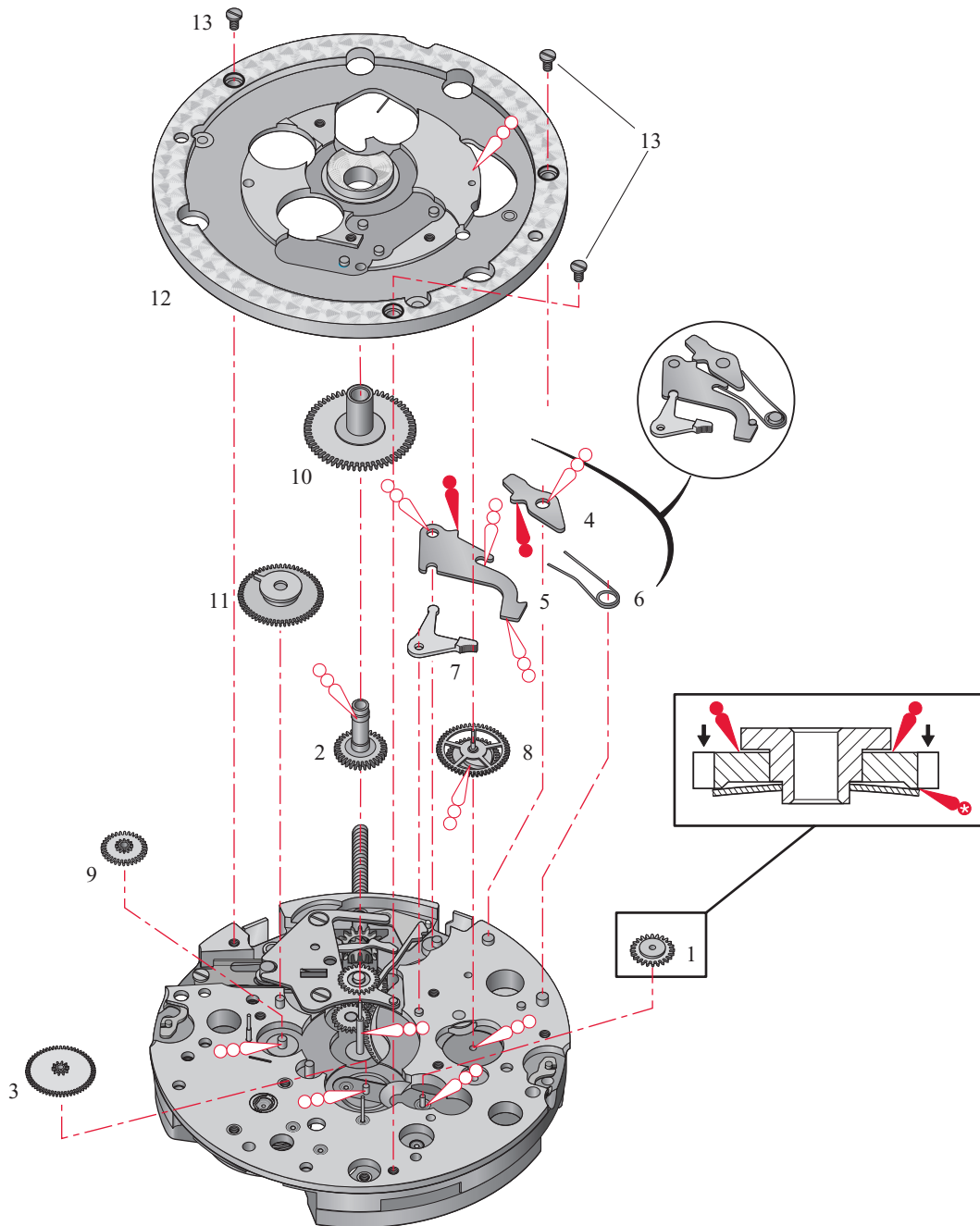

Phase 6

Liste des fournitures par ordre d'assemblage
Bestandteilliste in Montager Reihenfolge
Parts listed in order of assembly

- | | |
|-----------|-----------------|
| 1 = 25571 | 5 = 2550.1 (3x) |
| 2 = 2576 | 6 = 2569 |
| 3 = 2611 | 7 = 2535 |
| 4 = 2595 | 8 = 2550.1 (1x) |

 Huile épaisse
Dickflüssiges Öl
Thick oil

Moebius HP-1300SC

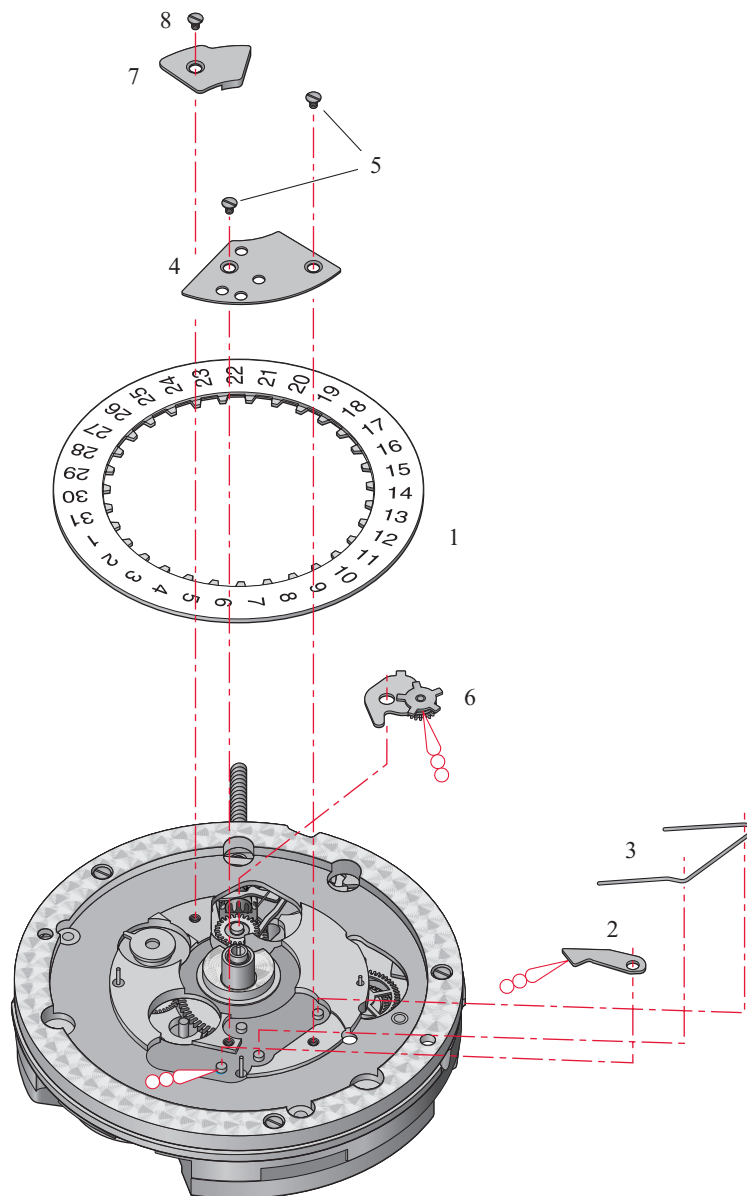















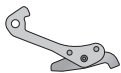





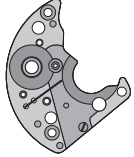







Listes des fournitures – Bestandteilliste – Spare parts list

100*	106*	121/4*	125*	144*	161	182*	195			
201/1	210	224	240	243	255	260	303/5*	358	375*	401*
407	410	415	420	423	434	435	437	440	443/1	445
450	705	710	721*	771	1142*	1143*	1428			
1481	1482	1488	2535	2543	2551*	2556	2557/1*			
2569	2576	2595	2611	3004	3005	8000	8020			

* Plusieurs versions disponibles / Verschiedene Versionen erhältlich / Several versions available

Listes des fournitures – Bestandteilliste – Spare parts list

								
8062	8079	8086	8140	8171	8200	8220		
								
8270	8290	8320	8335	8350	8356	8500*		
								
8600	8660	8670	8680	8690	8730	9433		
								
2550/1	2551/1	2841/1	3154	3250	3453/1	3454/1	3455/1	3457/1

* Plusieurs versions disponibles / Verschiedene Versionen erhältlich / Several versions available

Cal.	No CS	Désignation	Bezeichnung	Designation
1155	100	Platine, jaune	Werkplatte, gelb	Main plate, yellow
1155	100RB	Platine, rhodié RB	Werkplatte RB, rhodiniert	Main plate, rhodium-plated RB
1150	106	Pont de barillet et de rouage, jaune	Federhaus- und Räderwerkbrücke, gelb	Barrel and train wheel bridge, yellow
1151	106RB	Pont de barillet et de rouage, rhodié RB	Federhaus- und Räderwerkbrücke RB, rhodiniert	Barrel and train wheel bridge, rhodium-plated RB
1150	121/4	Pont de balancier, jaune	Unruhbrücke, gelb	Balance bridge, yellow
1151	121/4RB	Pont de balancier, rhodié RB	Unruhbrücke, RB, rhodiniert	Balance bridge, rhodium-plated RB
1150	125	Pont d'ancre, jaune	Ankerbrücke, gelb	Pallet bridge, yellow
1151	125RB	Pont d'ancre, rhodié RB	Ankerbrücke, RB, rhodiniert	Pallet bridge, rhodium-plated RB
1151	144	Fixateur de cadran, jaune	Zifferblatthalter, gelb	Dial fastener, yellow
1151	144/1	Fixateur de cadran, nicklé	Zifferblatthalter, vernickelt	Dial fastener, nickel plated
1150	161	Tube de centre	Zentrumlagerrohr	Centre tube
1150	182	Barillet complet, jaune	Federhaus, RB, gelb	Complete barrel, yellow
1151	182	Barillet complet, rhodié RB	Federhaus, RB, rhodiniert, komplett	Complete barrel, rhodium-plated RB
1150	195	Arbre de barillet	Federwelle	Barrel arbor
1150	201/1	Roue de grande moyenne	Grossbodenrad	Great wheel
1150	210	Roue moyenne	Kleinbodenrad	Third wheel
1150	224	Roue de seconde	Sekundenrad	Second wheel
1150	240	Chaussée entraîneuse	Mitnehmer-Minutenrohr	Driver cannon pinion
1155	243	Chaussée libre	Freies Minutenrohr	Free cannon pinion
1150	255	Roue des heures	Stundenrad	Hour wheel
1155	260	Roue de minuterie	Wechselrad	Minute wheel
1150	303/5	Raquette en 2 pièces	Rücker, zweiteilig	Two-piece regulator
1150	303/5ET	Raquette en 2 pièces, ETACHRON	Rücker, zweiteilig, ETACHRON	Two-piece regulator, ETACHRON
1150	358	Correcteur de raquette	Rückerkorrektor	Regulator corrector
1150	375	Porte-piton	Spiralklotzchenträger	Stud support
1150	375ET	Porte-piton, ETACHRON	Spiralklotzchenträger, ETACHRON	Stud support, ETACHRON
1150	401	Tige de remontoir, diamètre de filetage 1,20 mm	Aufzugwelle, Gewindedurchmesser 1,20 mm	Winding stem, thread diameter 1.20 mm
1150	401/1	Tige de remontoir, diamètre de filetage 0,90 mm	Aufzugwelle, Gewindedurchmesser 0,90 mm	Winding stem, thread diameter 0.90 mm
1150	407	Pignon coulant	Kupplungstrieb	Sliding pinion
1150	410	Pignon de remontoir	Aufzugtrieb	Winding pinion
1150	415	Rochet	Sperrad	Ratchet wheel
1150	420	Roue de couronne	Kronrad	Crown wheel
1150	423	Noyau de roue de couronne	Kronradkern	Crown wheel core
1150	434	Cliquet-ressort	Sperrfeder	Clicking spring
1150	435	Bascule de pignon coulant	Kupplungstriebhebel	Yoke
1150	437	Bascule de renvoi	Wippe	Rocking bar
1150	440	Ressort de bascule	Kupplungshebelfeder	Yoke spring
1150	443/1	Tirette	Winkelhebel	Setting lever
1150	445	Sautoir de tirette	Winkelhebelraste	Setting lever jumper
1150	450	Renvoi	Zeigerstellrad	Setting wheel
1155	453	Renvoi intermédiaire	Zwischen-Zeigerstellrad	Intermediate setting wheel
1150	705	Roue d'ancre	Ankerrad	Pallet wheel
1150	710ET	Ancre polie rubis	Anker, Rubine poliert	Pallet fork, ruby polished
1150	721	Balancier complet	Unruh komplett	Balance complete
1150	721ET	Balancier complet, ETACHRON	Unruh komplett, ETACHRON	Balance complete, ETACHRON
1150	771	Ressort de barillet	Federhaus-Triebfeder	Barrel-mainspring
1150	1142	Pont du dispositif automatique, jaune	Brücke für Automatik, gelb	Automatic device bridge, yellow
1150	1142RB	Pont du dispositif automatique, RB	Brücke für Automatik, RB	Automatic device bridge, RB
1155	1143/1	Masse oscillante, montée, jaune	Schwungmasse, montiert, gelb	Oscillating weight, assembled, yellow
1155	1143/1RB	Masse oscillante, montée, RB	Schwungmasse, montiert, RB	Oscillating weight, RB, assembled
1150	1428	Ressort d'inverseur	Feder für Wechsler	Reverser spring
1150	1481	Roue de réduction	Reduktionsrad	Reduction wheel
1150	1482	Roue entraîneuse de rochet	Mitnehmerrad für Sperrad	Ratchet wheel driving wheel
1150	1488	Roue d'inversion	Umkehrad	Reversing wheel
1155	2535	Plaque de maintien de l'indicateur de quantième	Halteplatte für Daturmaste	Date indicator maintaining plate
1155	2543	Roue intermédiaire de calendrier	Kalender-Zwischenrad	Intermediate calendar wheel
1155	2551	Planche de quantième, jaune	Datumplatte, gelb	Date platform, yellow
1154	2551/1	Planche de quantième, RB	Datumplatte, RB	Date platform, RB
1155	2556	Roue entraîneuse de l'indicateur de quantième	Datumanzeiger-Mitnehmerrad	Date indicator driving wheel
1155	2557/1*	Indicateur de quantième	Datumanzeiger	Date indicator
1155	2560	Roue entraîneuse de l'étoile des jours	Tagesstern-Mitnehmerrad	Day star driving wheel
1155	2569	Correcteur double	Doppelkorrektor	Double corrector
1155	2576	Sautoir de quantième	Datumraste	Date jumper

Cal.	No CS	Désignation	Bezeichnung	Designation
1155	2595	Plaque de maintien du sautoir de quantième	Halteplatte für Datumanzeiger	Date jumper maintaining plate
1155	2611	Ressort des sautoirs	Rastenfeder	Jumper spring
1150	3004	Amortisseur empierré, dessus	Stoss-Sicherung mit Stein, oben	Jewelled shock-absorber, to press in
1150	3005	Amortisseur empierré, dessous	Stoss-Sicherung mit Stein, unten	Jewelled shock-absorber, to press in
1150	8000	Roue de chronographe	Chrono-Zentrumrad	Chronograph wheel
1150	8020	Roue compteuse de minutes	Minutenzählrad	Minute-counting wheel
1154	8062ET	Roue entraîneuse du compteur de minutes	Mitnehmerrad für Minutenzählrad	Minute counter driving wheel
1150	8079	Embrayage, 2 fonctions	Kupplung, 2 Funktionen	Clutch, 2 functions
1150	8086	Pignon oscillant	Schwingtrieb	Oscillating pinion
1150	8140	Commande, 2 fonctions	Schalthebel, 2 Funktionen	Operating lever, 2 functions
1150	8171	Came de chronographe	Nocken für Chronograph	Chronograph cam
1150	8180	Bascule de remise à zéro	Nullstellerwippe	Fly-back yoke
1150	8182	Tenon de bascule de remise à zéro	Lagerstift für Nullstellerwippe	Fly-back lever stud
1154	8200ET	Bloqueur, 2 fonctions	Blockierhebel, 2 Funktionen	Lock, 2 functions
1150	8220	Marteau, 2 fonctions	Herzhebel, 2 Funktionen	Hammer, 2 functions
1150	8270	Sautoir du compteur de minutes	Minutenzählrad-Raste	Minute counter jumper
1150	8290	Friction de roue de chronographe	Friktion für Chrono-Zentrumrad	Chronograph wheel friction
1150	8320	Ressort d'embrayage, 2 fonctions	Kupplungsfeder, 2 Funktionen	Clutch spring, 2 functions
1150	8335	Ressort de commande, 2 fonctions	Schalhebelfeder, 2 Funktionen	Operating lever spring, 2 functions
1150	8350	Ressort de marteau, 2 fonctions	Herzhebelfeder, 2 Funktionen	Hammer spring, 2 functions
1150	8356	Sautoir de came de marteau	Raste für Herzhebellocken	Hammer cam jumper
1150	8401	Excentrique-appui d'embrayage	Exzenter für Kupplungs-Anschlag	Clutch banking eccentric
1150	8407	Excentrique du sautoir du compteur de minutes	Exzenter für Minutenzählradraste	Minute counter jumper eccentric
1150	8500	Pont de chronographe, jaune	Chrono-Brücke, gelb	Chronograph bridge, yellow
1150	8500RB	Pont de chronographe, RB	Chrono-Brücke, RB	Chronograph bridge, RB
1150	8600	Roue compteuse d'heures	Stundenzählrad	Hour-counting wheel
1150	8660	Interrupteur	Unterbrecher	Switch
1150	8670	Commande du marteau d'heures	Schalthebel für Stunden-Herzhebel	Hour hammer operating lever
1150	8680	Marteau d'heures	Stunden-Herzhebel	Hour hammer
1150	8690	Bloqueur du compteur d'heures	Blockierhebel für Stundenzähler	Hour counter lock
1150	8730	Ressort du marteau d'heures	Stunden-Herzhebelfeder	Hour hammer spring
1150	9433	Levier stop	Stopphebel	Stop lever
0000	3250	1x Vis de piton	Schraube für Spiralklotzenträger	Screw for stud
0000	3454	1x Vis de rochet	Schraube für Sperrad	Screw for ratchet wheel
0000	3454	2x Vis de noyau de roue de couronne	Schraube für Kronradkern	Screw for crown wheel core
0000	3454	1x Vis de ressort de bascule	Schraube für Kupplungshebelfeder	Screw for yoke spring
0000	2550	1x Vis de plaque de maintien de l'indicateur de quantième	Schraube für Halteplatte für Daturmaste	Screw for date indicator maintaining plate
0000	2550	2x Vis de plaque de maintien du sautoir de quantième	Schraube für kombinierte Halteplatte für Datumanzeiger	Screw for date jumper maintaining plate
0000	2551	2x Vis de sautoir de tirette	Schraube für Winkelhebelraste	Screw for setting lever jumper
0000	2841	1x Vis de masse oscillante	Schraube für Schwungmasse	Screw for oscillating weight
107	3154	2x Vis de bride	Schraube für Befestigungsplättchen,	Screw for casing clamp
0000	3453	2x Vis de pont d'ancre	Schraube für Ankerbrücke	Screw for pallet bridge
0000	3453	3x Vis de pont du dispositif automatique	Schraube für Automatikbrücke,	Screw for automatic device bridge
0000	3453	3x Vis de pont de barillet et de rouage,	Schraube für Federhaus- und Räderwerkbrücke	Screw for barrel and wheel train bridge
0000	3453	1x Vis de bloqueur	Schraube für Blockierhebel	Screw for lock, flat, polished
0000	3453	1x Vis de sautoir du compteur de minutes	Schraube für Minutenzählradraste	Screw for minute counter jumper
0000	3453	2x Vis de pont de chronographe	Schraube für Chrono-Brücke,	Screw for chronograph bridge
0000	3454	3x Vis de planche de quantième	Schraube für Datumplatte	Screw for date platform
0000	3455	1x Vis de commande	Schraube für Schalthebel	Screw for operating lever
0000	3455	1x Vis de came de chronographe	Schraube für Nocken für Chronograph	Screw for chronograph cam
0000	3457	1x Vis de pont de balancier	Schraube für Unruhbrücke	Screw for balance bridge

* Plusieurs versions disponibles / Verschiedene Versionen erhältlich / Several versions available

Système de fonctionnement du mouvement

Funktionssystem des Uhrwerks

Functioning system of movement

- Rouage, échappement et balancier / Räderwerk, Hemmung und Unruh / Wheel train, escapement and balance
- Système de chronographe / Chronographensystem / Chronograph system
- Côté cadran / Zifferblattseite / Dial side

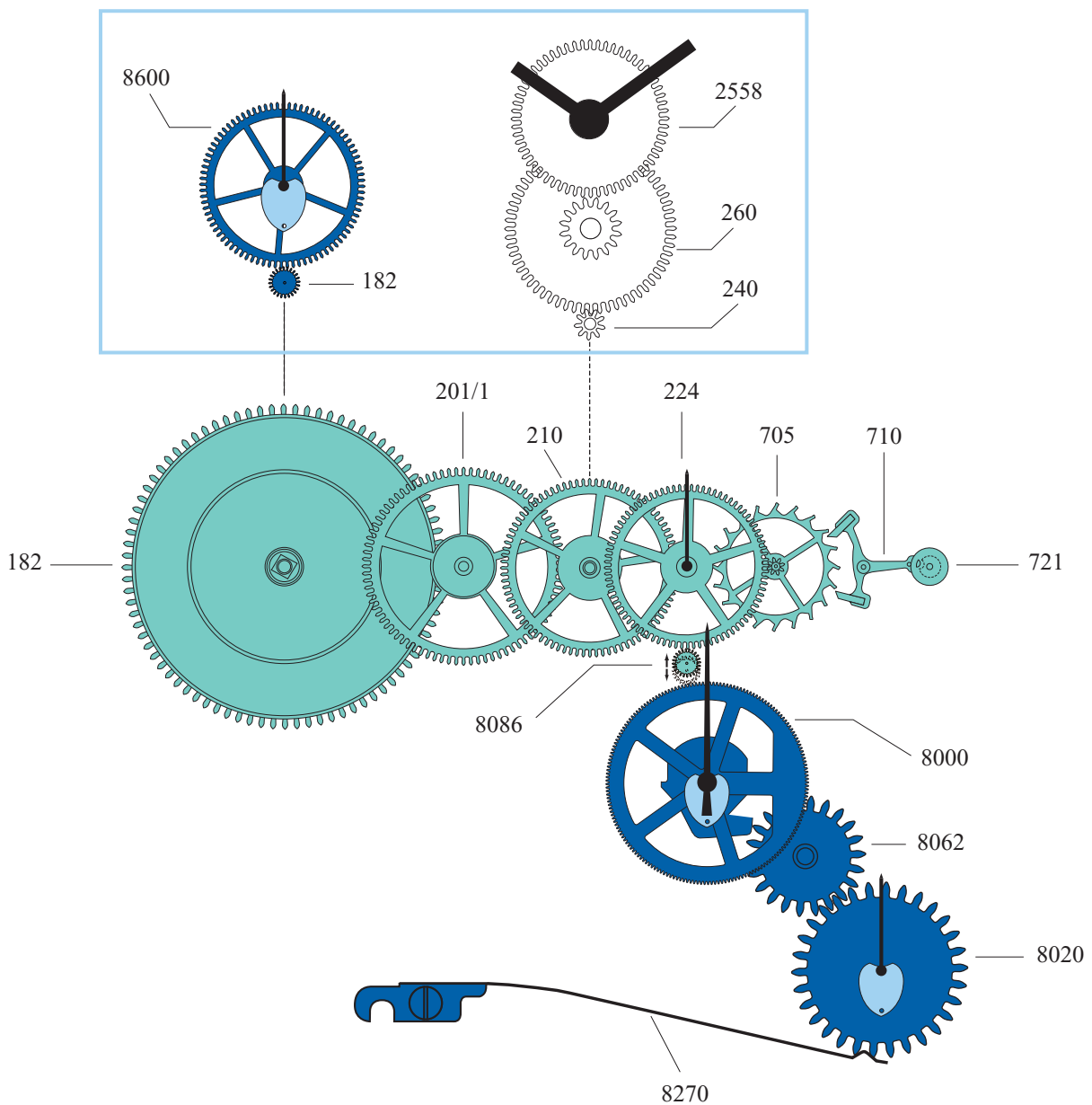

Réglage du chronographe – Einstellen des Chronographen – Setting the chronograph

Contrôle et ajustement de la position de la roue compteuse de minutes

Le contrôle et les ajustements de la position du compteur minutes se fait dans l'ordre chronologique comme ci-dessous :

- 1.1 Pousser le marteau (8220) en arrière...
- 1.2 ...et en même temps contrôler la synchronisation de la position du sautoir du compteur de minutes (8270) avec la roue compteuse de minutes (8020).
- 1.3 Si la roue compteuse de minutes bouge à gauche ou à droite en poussant le marteau en arrière, la position de l'excentrique doit être modifiée.
- 1.4 Faire attention à ce que le sautoir du compteur de minutes touche le pont afin que sa tension soit correcte.

Kontrolle und Einstellung der Position des Minutenzählrades

Die Kontrolle und Einstellung der Position des Minutenzählrades erfolgt in chronologischer Reihenfolge wie nachfolgend beschrieben:

- 1.1 Den Herzhebel (8220) zurückgestossen...
- 1.2 ...und gleichzeitig die Synchronisation der Position der Minutenzählrad-Raste (8270) mit dem Minutenzählrad (8020) kontrollieren.
- 1.3 Bewegt sich das Minutenzählrad nach Links oder Rechts wenn der Herzhebel bewegt wird, so muss die Position des Excenters verändert werden.
- 1.4 Die Minutenzählrad-Raste muss mit der Brücke Kontakt haben um die richtige Spannung zu gewährleisten

Control and adjustment of the minute counting-wheel

The control and adjustment of the minute counting-wheel position is made in a chronological order as explained on the following lines:

- 1.1 Move the hammer (8220) backwards...
- 1.2 ...and control the synchronization of the position of the minute counter jumper (8270) with the minute counting-wheel (8020).
- 1.3 If the minute counting-wheel moves left or right when moving back the hammer, the position of the eccentric must be modified.
- 1.4 The minute counter jumper must have contact with the bridge to assure the correct tension.

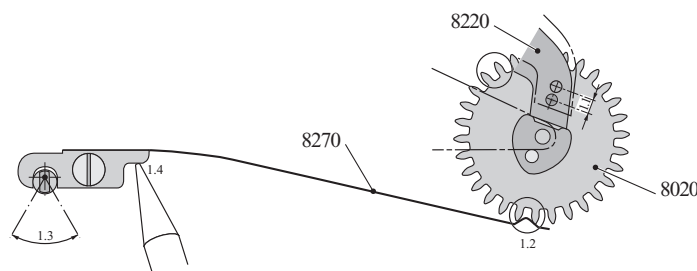

Contrôle et ajustement de la position du doigt de la roue chronographe

- 2.1 Contrôler que la partie longue du doigt est absolument droite. Si ce n'est pas le cas, il faut modifier la forme avec une brucelle fine.
- 2.2 Contrôler que la face d'impulsion du doigt est également bien droite.
- 2.3 Contrôler que l'angle se situe entre 90 – 100 degrés.
- 2.4 La pénétration du doigt dans la roue entraîneuse (8062) peut être ajustée au point A. Elle ne doit pas être plus profonde que le rattrapage du jeu d'engrènement entre la roue compteur de minutes et la roue entraîneuse (point 2.5).

Kontrolle und Einstellung der Position des Fingers des Chronozentrumsrades

- 2.1 Es muss kontrolliert werden, dass der lange Teil des Fingers absolut gerade ist. Ist dies nicht der Fall, muss die Form des Fingers mit einer kleinen Kornzange modifiziert werden.
- 2.2 Die Impulsfläche des Fingers muss ebenfalls eine Gerade bilden.
- 2.3 Der Winkel des Fingers muss zwischen 90 – 100 Grad betragen.
- 2.4 Die Penetration zwischen dem Finger und dem Mitnehmerrad (8062) kann in Punkt A verändert werden. Diese darf nicht tiefer sein als das Eingriffsspiel zwischen dem Mitnehmerrad und dem Minutenzählrad (Punkt 2.5).

Control and adjustment of the position of the chronograph wheel finger

- 2.1 Control that the long part of the finger is absolutely straight. If not, the finger shape must be modified by a small tweezer.
- 2.2 Control that the finger impulse face is straight as well.
- 2.3 Control that the angle of the finger is between 90 – 100 degree.
- 2.4 The penetration of the finger with the driving wheel (8062) can be adjusted in point A. It should not be deeper than the catch up of the minute counting-wheel and the driving wheel gear (point 2.5).

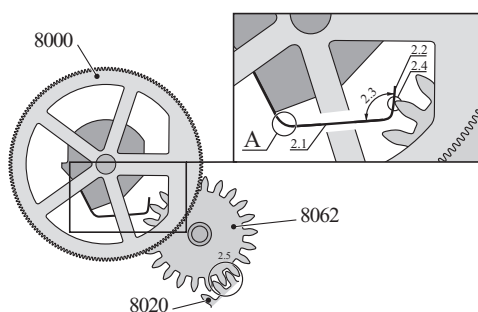

Réglage – Gangkontrolle – Timing

Démagnétiser le mouvement avant les contrôles.

Positions de réglage:

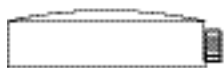

CH

Das Werk ist vor allen Prüfungen zu entmagnetisieren.

Kontrollpositionen:

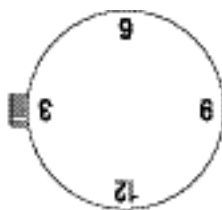

GH

Demagnetize the movement before the checks.

Timing positions:



9H

Alternances:	28'800 A/h	Halbschwingungen:	28'800 A/h	Frequency:	28'800 A/h
Angle de levée:	50°	Hebungswinkel:	50°	Angle of lift:	50°
Réserve de marche:	44 heures	Gangreserve:	44 Stunden	Power reserve:	44 hours
Perte d'amplitude maximum avec chronographe en marche:	40°	Maximaler Amplitudenverlust bei eingeschaltetem Chronographen:	40°	Maximum loss of amplitude with chronograph in operation:	40°

	MM 0 h	Δ 0 h	Δ 24 h	Ampl. 24 h VB	Réserve de marche Gangreserve Power reserve
Valeurs limites (sans chronographe) Max. Werte (ohne Chronograph) Max. values (without chronograph)	-1 / + 11	15 sec.	20 sec.	200°	44 h

MM 0 h:	Marche moyenne dans les 3 positions à 0 heure. (entre 30 et 90 minutes après le remontage complet).	MM 0 h:	Mittlerer Gang der 3 Positionen bei 0 Uhr. (zwischen 30 und 90 Minuten nach Vollaufzug).	MM 0 h:	Average rate in the 3 positions at 0 hour. (between 30 and 90 minutes after complete winding).
Δ 0 h:	La plus grande différence de marche dans les 3 positions à 0 heure (entre 30 et 90 minutes après le remontage).	Δ 0 h:	Größte Gangdifferenz der 3 Positionen bei 0 Uhr (zwischen 30 und 90 Minuten nach Vollaufzug).	Δ 0 h:	The biggest rate difference in the 3 positions at 0 hour (between 30 and 90 minutes after complete winding).
Δ 24 h:	La plus grande différence de marche dans les 3 positions après 24 heures (entre 23 h 30 et 25 heures après le remontage complet).	Δ 24 h:	Größte Gangdifferenz der 3 Positionen nach 24 Stunden (zwischen 23 30 und 25 Stunden nach Vollaufzug).	Δ 24 h:	The biggest rate difference in the 3 positions after 24 hours (between 23 h 30 and 25 hours after complete winding).
Ampl. 24 h:	Amplitude minimum en position verticale après 24 heures.	Ampl. 24 h:	Minimale Amplitude in vertikaler Positionen nach 24 Stunden.	Ampl. 24 h:	Minimum amplitude in vertical position after 24 hours.

Aiguillage – Zeigerwerkhöhe – Hand fitting height

Ajustement aiguille des heures
Stundenzeigerpassung
Hour hand fitting

Ajustement aiguille des minutes
Minutenzeigerpassung
Minute hand fitting

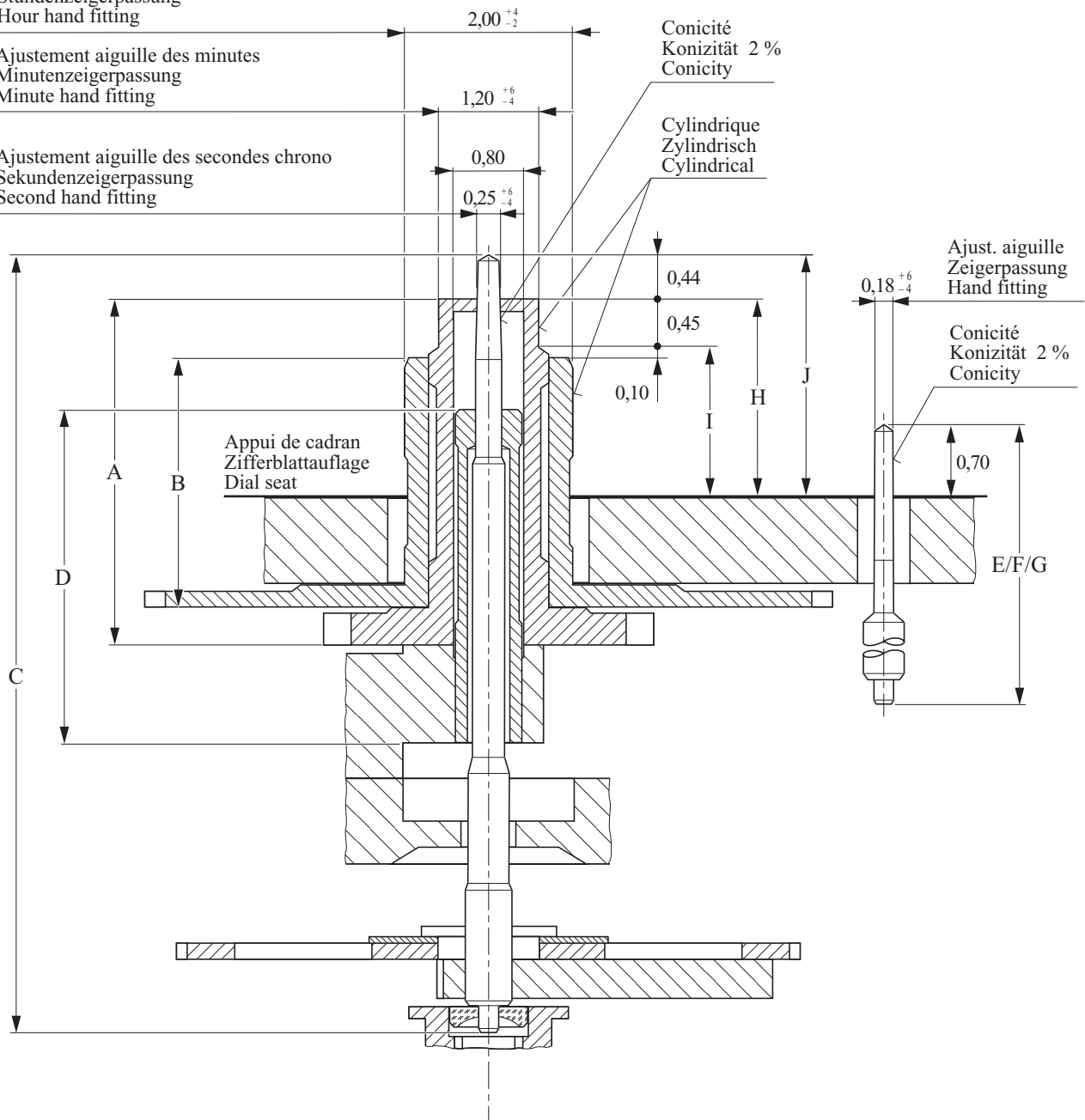

Ajustement aiguille des secondes chrono
Sekundenzeigerpassung
Second hand fitting



Aiguillage Zeigerwerk- höhe Hand fitting height	Longueur / Länge / Length mm						
	A	B	C	D	E	F	G
Chaussée Minutenrohr Cannon-pinion	Roue des heures Stundenrad	Roue de chronographe Chrono- zentrumrad Chrono wheel	Tube de centre Zentrumrohr Centre tube	Roue des secondes Sekundenrad	Roue compt. minutes Minuten- zählrad Minute count. wheel	Roue compt. heures Stunden- zählrad Hour count. wheel	
1	4,05	3,00	9,13	4,10	5,81	7,50	2,78

	Guide technique / Technische Anleitung / Technical Guide		TG-19-C-056-FDE	B
	Fait par: pelrom	Date: 03.09.2007		

Release of Technical Guide			
Date of first release:	02.06.2003	Made by	Pelrom
Date of last release:	03.09.2007		

Traceability of modifications version B			
<i>Replacement of lubricants</i>			
	Old	New	Date:
	Moebius Microgliss D5	Moebius SYNT-HP-1300	02.06.2003
	Moebius 9020	Moebius SYNT-HP-500	
	Moebius 9501	Moebius 9504	
	Escappement wheel lubricated with HP-1300 Sans Colorant	Escappement wheel lubricated with Moebius 9010	03.09.2007